



www.cmrelectrical.com

LD32

Water Leak Detection Manual



Contents

- 1) **System Overview**
- 2) **Display and Control**
- 3) **Water Detected Alarm**
- 4) **Sensor Fault Alarm**
- 5) **Relay Outputs**
- 6) **Mute Push Button**
- 7) **Light Push Button**
- 8) **Info Push Button**
- 9) **Beacon and Beacon Sounder**
- 10) **Fitting SCA Repeat Alarm or SMS / Email Messaging System**
- 11) **Outstation**
- 12) **Positioning the Outstations**
- 13) **Fitting and Wiring Alarm Unit**
- 14) **Outstation Wiring**
- 15) **RS485 Data Cable End of Line Resistor**
- 16) **Positioning the Water Detection Cable**
- 17) **Fitting Cable Clips**
- 18) **Mounting a Spot Probe**
- 19) **Water Detection Sensitivity Adjustment**
- 20) **Water Shutdown Valve**
- 21) **Water Shutdown Valve Override Procedure**
- 22) **Fitting the Battery Backup**
- 23) **Commissioning**
- 24) **Maintenance**
- 25) **Fault Diagnostics**
- 26) **Installation Drawings**
- 27) **Optional Modbus TCP interface**

1) System Overview

The unit has been designed to interrogate individual outstations and report back to the main controller if water or a disconnected sensor is found. On powering up, the unit will display “SETTING UP PLEASE WAIT” until all remote outstations have been interrogated for their current status. Providing there are no alarms or faults on the system, the displays backlight will change to green and all zones will be shown as “NORMAL”.

With the system clear from alarms or faults, after five minutes the display will go into power saving mode by turning off the backlight. If required, the light can be turned back on again for a further five minutes by pressing the “Light” button.

When a water leak is detected, the zone “Alarm” lamp contained within the appropriate outstation will start to flash. This has been provided to give maintenance staff local alarm status indication, thereby alleviating the need to keep interrogating the main alarm controller for an update. Also, if fitted within the outstation, the appropriate water shutoff valve will close thereby removing the risk of further water damage. At the same time, the alarm will be displayed on the controller’s screen in large letters i.e., “WATER DETECTED ZONE 15”, with the display backlight flashing between red and white.

The internal “New Alarm”, “Common Alarm” relays will change state, the audible warning device will sound and if fitted (optional equipment), the sounder beacon will start up, the text messaging system will send a text and the individual BMS relay will operate.

On pressing the “Mute” button, the display will change to the normal screen, but with a white backlight, the zone in alarm screen statement will flash i.e. “Zone 15 ALARM”, the internal warning device will stop, the “New Alarm” relay will de-energise leaving the common alarm relay still energised and if fitted (optional equipment) the remote sounder will stop, leaving the beacon flashing.

Once the water has been removed from the sensor and provided the alarm has been muted, the system will automatically reset itself back to normal operation. Please note, the outstation Alarm lamp is a true current state indication and unlike the main control unit, it is not latched and therefore muting is not required for a reset.

The outstation also monitors all water detection cables and sensors for disconnection. If a fault is found, the appropriate “Fault” lamp on the outstation will start to flash, again this has been provided to give maintenance staff local alarm status indication. In the same way as described above, the fault will also be shown on the screen but with the appropriate statement i.e., “SENSOR FAULT ZONE 15” the audible warning device will sound, and only the common fault relay will energise.

On pressing the “Mute” button, the display will change to the normal screen, but with a white backlight. The zone in alarm screen statement will flash i.e., “Zone 15 FAULT”, and the internal warning device will stop. Providing the mute button has been operated, once the fault has been rectified, the system will automatically revert back to normal operation. Please note, the outstation Alarm lamp is a true current state indication and unlike the main control unit, it is not latched and therefore muting is not required for a reset.

A lamp has been provided on each outstation identified as “Active” this lamp indicated that the outstation is successfully communicating with the main alarm unit and should be flashing at a rate of 1-2 seconds. An active lamp is also provided for the same reason, within the main alarm unit and should appear flashing at a high speed or be permanently on.

A button identified as “Info” is provided on the screen of the alarm unit. Pressing this will display the number of expected zones, the total number of outstations that should be fitted to the system, the total number of current alarms (water leaks) and the total number of current faults (disconnected sensor). If the “Exit” button is not pressed within 5 seconds, the unit will automatically revert back to the main screen.

If fitted, some or all the outstations might contain a water shutoff control board. This additional feature requires a 230VAC supply to drive the remotely fitted water valves. Depending upon the type of configuration asked for at the time of ordering, *i.e.*, each zone with its own valve or all zones controlling the same valve, a 230VAC two core cable needs to be run between the appropriate outstations L E N terminals to the valve.

Lights have been provided to indicate if the valve has been asked to close. In normal operation with no alarms these lights should be off and will only illuminate when the valve is asked to close. If required, positioned on the outstations top board is a push button identified as “Valve Override”. Pressing this with no alarms on the outstation will do nothing. However, if the outstation has an alarm (water detected), pressing will start an audible pulsing sound. Keeping the button pressed until the sound stops, will illuminate the “Valve Override” lamp (top board), and open the shutdown valve.

2) Display and Control

Screen 1

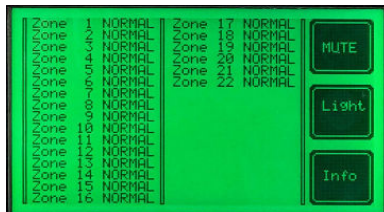

Normal, no alarm or faults

Screen 2

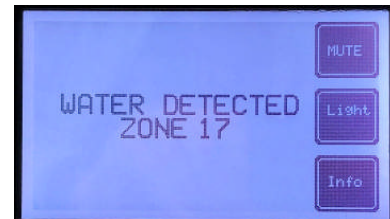

Unacknowledged (new) water leak detected

Screen 3

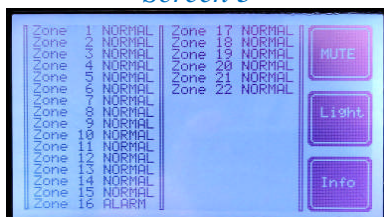

Acknowledged water detected alarm

Screen 4



Unacknowledged (new) cable fault

Screen 5

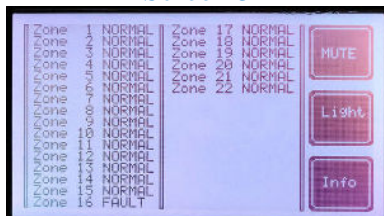

Acknowledged cable fault

Screen 6



System information

3) Water Detected Alarm

When the detection cable comes into contact with water anywhere along its length, the audible warning device will start, the new alarm and common alarm relay will operate and the display will start flashing with the zone number. To stop the audible warning, press the “Mute Alarm” button. On muting, the display will stop flashing and display screen 3. The system will remain in this state until the water is removed from the cable.

4) Sensor Fault Alarm

Because of the exposure of the detection cable on the floor, the system monitors for any breaks in the detection cable and the interconnection cable between the control unit and the detection cable. Provided continuity is maintained, the unit will display screen 1. If a break within the cable is found, the audible warning device will start, the fault relay will operate and the display will start flashing and change to screen 4. To stop the audible warning press the “Mute Alarm” button. On muting, the screen will stop flashing indicating an acknowledged alarm and change to screen 5. The system will remain in this state until the cable fault is repaired, when the display will revert back to screen 1. If the controller detects a break in the cable, the system will continue to detect water up to the point of the break.

5) Relay Outputs

Three sets of volt free contacts have been provided for the following and can be found within the unit on the main PCB. The “New Alarm” contact is provided to advise a BMS system when the system sees a new water detected alarm, or a new sensor disconnected alarm. After acknowledging the new alarm, this relay re-sets and arms itself for the next event.

- a) 1 x Common Alarm (Any zone detecting water will energise this relay)
- b) 1 x New Alarm (Only a new alarm or fault will energise this relay which turns off when muted)
- c) 1 x Common Fault (Any sensor becoming disconnected will energise this relay, see note below)

NOTE: the common fault N/O, Com, and N/C statements on the PCB are only true when the unit is powered down.

5a) Outstation Common Alarm Relay

Each outstation has its own common alarm relay for just the zones fitted to the outstation.



Located on the top left of the outstation board (see above) use the two terminals provided.

Note; this contact is only normally open, close in alarm.

6) “Mute” Push Button

The mute button is provided to silence the audible warning device. This button will also silence the remote sounder if fitted.

7) “Light” Push Button

In darkened areas, if the display back light is off, pressing the “light” will turn it on for 5 minutes.

8) “Info” Push Button

Use this button to display the current status of the system. Displayed are the total number of expected system zones, the total number of expected outstations, the total number of current water detected alarms and the current number of cable faults. Pushing the “Exit” button will revert to the normal screen. After five minutes, the system will automatically revert back to the normal screen if the Exit button is not pressed.

9) Beacon and Beacon Sounder

If a beacon or beacon sounder is supplied connect to the three terminals identified as “Beacon” as follows:

9a) Non Mutable Beacon or Beacon Sounder

If the beacon or the beacon sounder is to be active (on all the time) until the water leak alarm has cleared, connect as follows:

Terminal Reference	Connect Beacon / Beacon Sounder terminals to the following terminals
+V	Beacon +V or Strobe /Tone + terminal
BOV	Beacon -V or Strobe /Tone - terminal
SOV	NO connection to this terminal

9b) Mutable Beacon or Beacon Sounder

If the beacon or the beacon sounder is to turn off when the “Mute” push button is pressed, connect as follows:

Terminal Reference	Connect Beacon / Beacon Sounder terminals to the following terminals
+V	Beacon +V or Strobe /Tone + terminal
BOV	NO connection to this terminal
SOV	Beacon -V or Strobe /Tone - terminal

9c) Mutable Sounder Beacon on all the time

If the beacon is to remain alight all the time an alarm is current but the sounder is to be turned off when the “Mute” push button is pressed, connect as follows:

Terminal Reference	Connect Beacon / Beacon Sounder terminals to the following terminals
+V	Strobe and Tone + terminal
BOV	Strobe - terminal
SOV	Tone - terminal

Warning; if the above option “9c” is required, **remove** the electrical link connected between the second (Strobe -) & third terminals (Tone -) terminals within the sounder.

10) Fitting SCA Repeat Alarm or SMS Messaging System

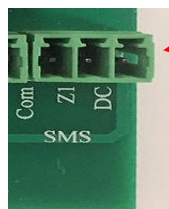

Use the “SMS” terminal block

SCA Terminal No.	SMS Terminal No.	Cable wire colours fitted to the messaging system
+V	DC	RED
Sig	Z1	BLUE
0V	COM	BLACK

11) Outstation

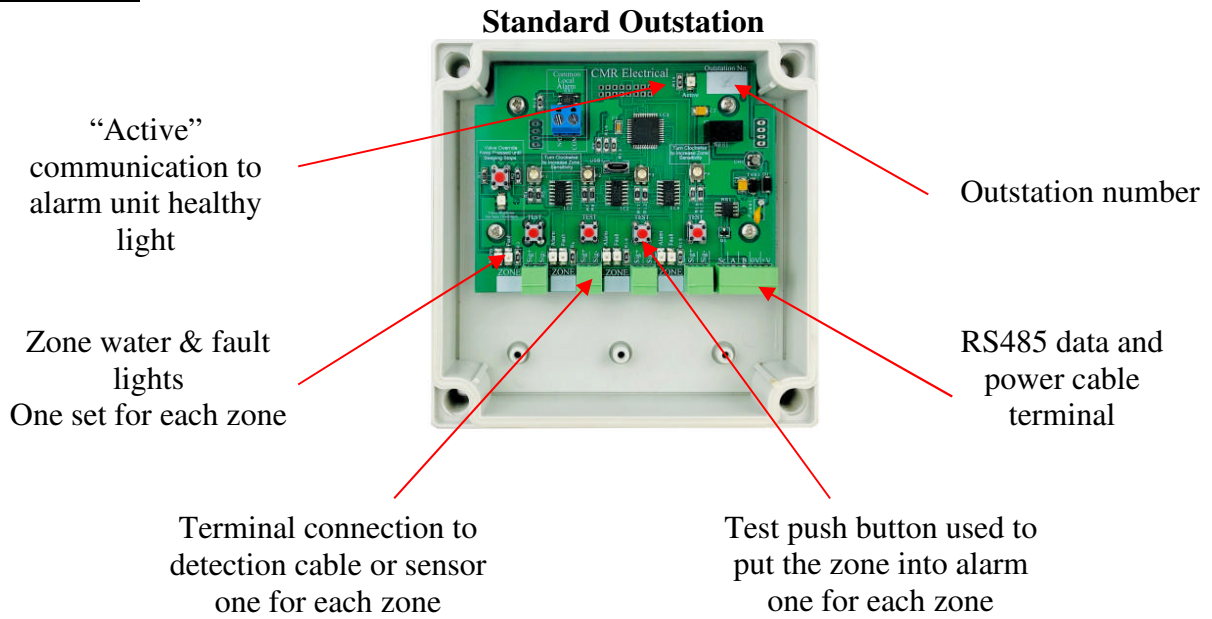

Outstation with Shutdown Valve Control

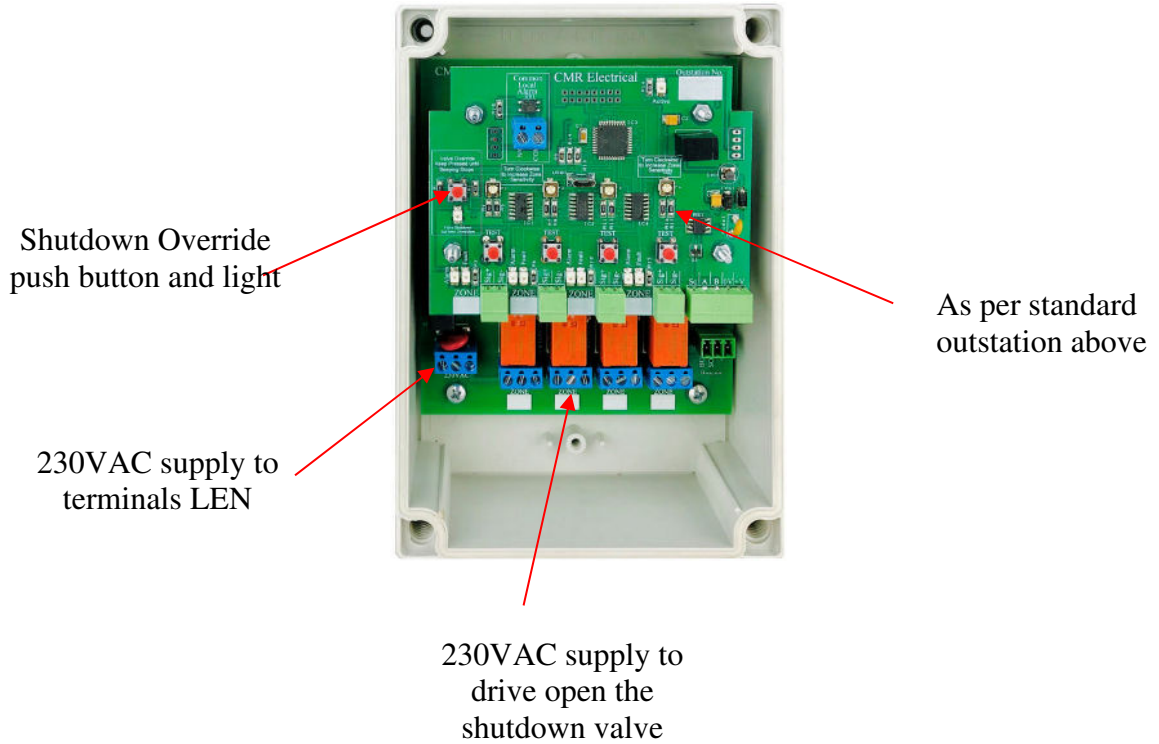

12) Positioning the Outstations

All outstations are wall mounted using the fixing points located in each corner behind the removable front cover. Outstations should be mounted in a position to allow accessibility to the internal components and cables.

13) Fitting and Wiring Alarm Unit

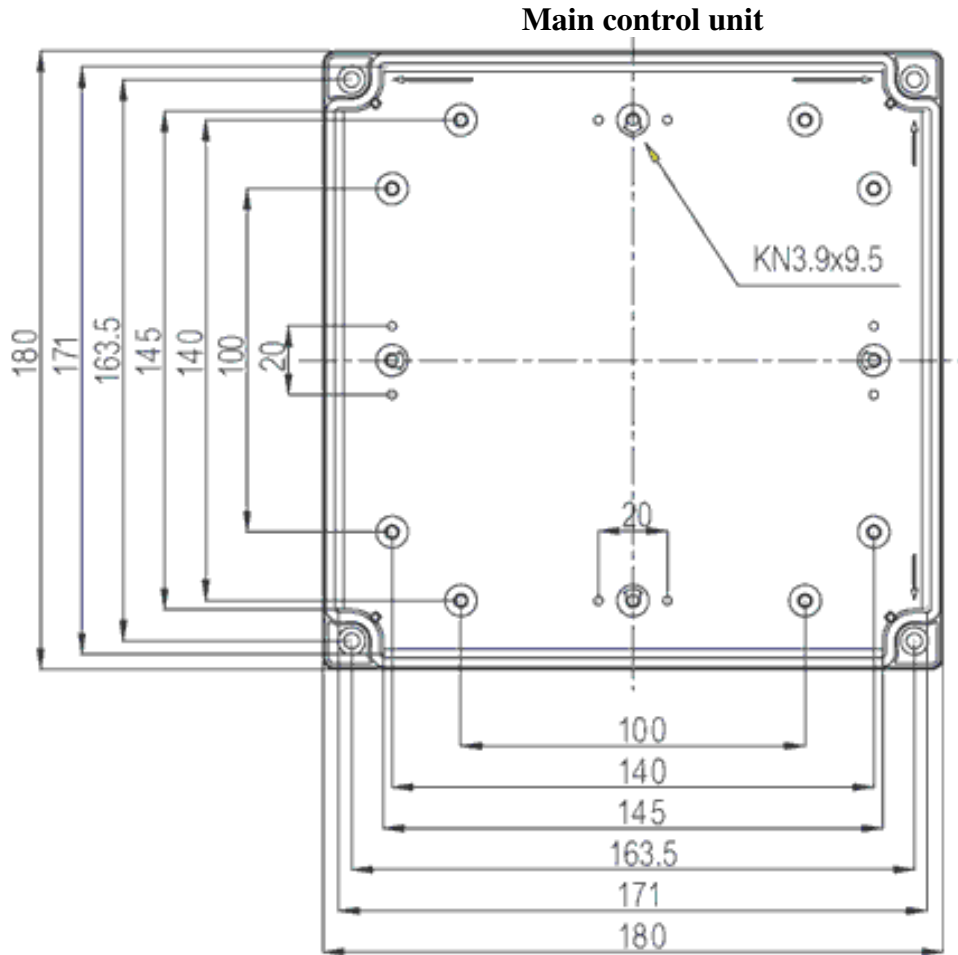

THIS EQUIPMENT SHOULD ONLY BE CONNECTED AND WORKED ON BY A QUALIFIED ELECTRICIAN.

To mount the unit to a wall, first remove the front cover to expose the internal equipment. In each corner of the housing you will find the mounting holes. Care should be taken when drilling the holes to ensure no damage occurs to the electronic equipment. A suitably rated 230VAC power cable supply should be run from a fused spur to the unit and terminated to the internal terminal block marked “L”, “E” & “N”. The fuse within the fused spur should be rated at 5 Amps.

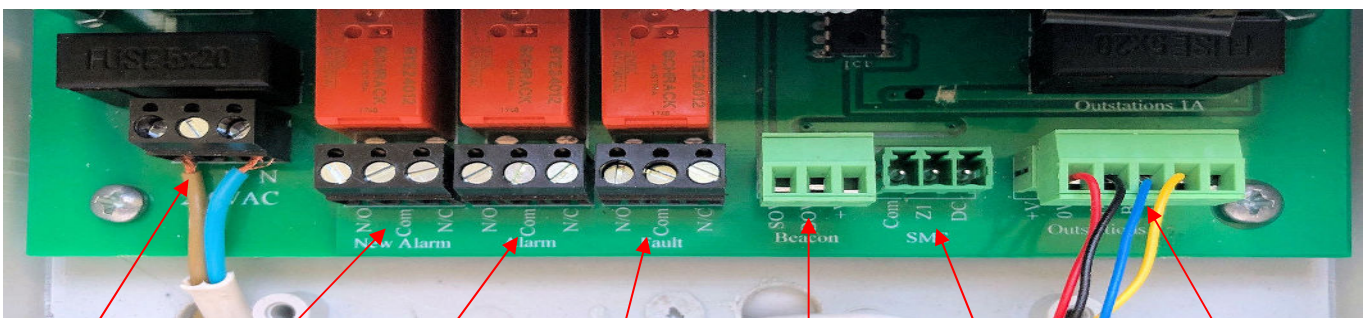

230VAC Mains Input

New Alarm/Fault Contact

Common Alarm Volt Free Contact

Common Fault Contact
See Item 5 above

If Fitted Beacon/Sounder

If Fitted SMS Text

RS485 data and power to outstations

Output Volt Free Contacts for use by a Building Management System

Function Required	Function
New Alarm	Operates on each new water leak alarm or sensor fault, reset by muting
Common Alarm	Any zone in water alarm, clears with no water alarms on the system
Common Fault	Operates on disconnected sensor or power fault (<i>See Item 5 above</i>)
Power Fault	See Common Fault

14) Outstation Wiring

Using a Belden 0.5mm 4 core industrial cable type YE00906.00100 or similar, connect the cable from the controllers RS485 terminal block shown above, to the outstation 5way terminal block as shown below. It is important that the cable run is laid out in a daisy chain pattern, i.e., main alarm unit (above) to the nearest outstation, then on to the next outstation one after the other, avoiding teeing off the main line.

Main Controller Terminal Number	Outstation Terminal Number
+V (Red)	+V (Red)
0V (Black)	0V (Black)
A (White)	A (White)
B (Yellow)	B (Yellow)

Use the "SC" terminals to terminate the cable screening cable

14a) Relay Outstations

The relay outstation is provided in applications where a volt free alarm contact for all zones is required such as a Building Management System. Connection is shown above and in Item 25's installation drawing below.

15) RS485 Data Cable End of Line Resistor

As with all RS485 data lines, a 120Ω resistor MUST be fitted at the end of the data cable run, this being the furthest away from the alarm unit in cable length terms. This resistor can be found fitted to the RS485 terminal block in the last (highest numbered) outstation. The outstation number can be found in the top right-hand corner of each outstation. If this outstation is not the furthest away, remove the resistor and terminate it between terminals "A" & "B" on the appropriate outstation. Being a resistor, it is NOT polarity dependant.

Standard Outstation

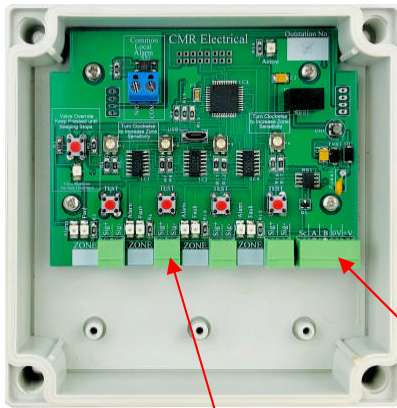

Valve Control Outstation

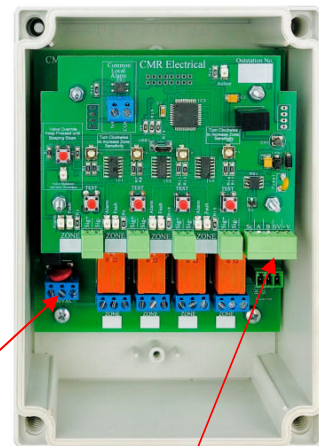

Connect a 230VAC supply to terminals
LEN

Water detection sensor wiring
Only the Red and Black cables in the white signal cable are used.
Red wire to Sig+
Black wire to Sig-

Wrongly or badly connected wiring will result in intermittent faults or alarms. The end of line terminator MUST be fitted

RS485 terminal block layout
Sc|A|B|0V|+V

<u>Control unit</u>	to	<u>Outstation</u>
Sc	to	Sc (Screen wire)
A	to	A (wire 1)
B	to	B (wire 2)
0V	to	0V (wire 3)
+V	to	+V (wire 4)

Wrongly or badly connected wiring will result in damage or intermittent alarms or faults

Water Detection and Signal Cable

Water Leak Detection Cable; run around the area to be protected

End of line Terminators; Plug MUST Be fitted at the end of the detection cable



Signal cable; maximum 50 metres long, to water detection cable connectors

Terminate the Red and Black wires to zone terminals within the alarm unit as shown above

Signal cable used to connect the water detection cable, to the alarm unit

16) Positioning the Water Detection Cable

The detection cable is susceptible to damage and should not be fitted to areas where the cable is likely to be damaged or walked on, unless a perforated steel cover is used. If fitting the cable around Air Conditioning Units with humidifiers, ensure that cable is positioned at least one metre from the ACU to stop intermittent alarms being generated from over humidity or water droplets. Having positioned the detection cable, ensure that the end of line terminator is plugged into the end of the cable (see drawing above).

17) Fitting Cable Clips

If Cable Clips are required, to protect the small sensor wires and to stop false water detected alarms from occurring, insulating tape should be first applied around the detection cable before the clip tongue is closed. Clips should be fitted approximately every 1 to 1.5 metres apart. When using clips make sure that the cable touches the floor between the clips, **DO NOT** tighten the cable so that the cable does not touch the floor.

Insulating Tape Under the fixing clip tongue

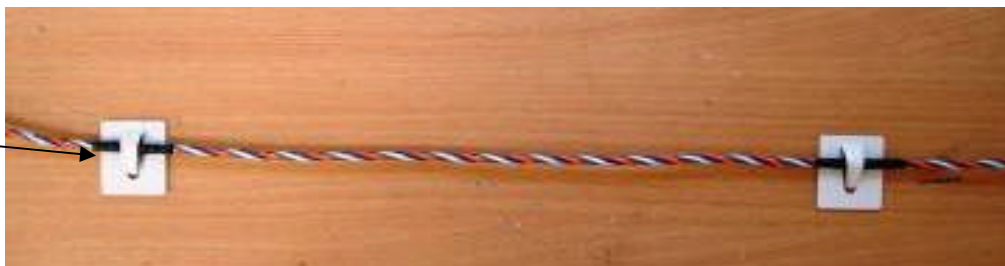

18) Mounting a Spot Probe

Spot probes are supplied with a mounting bracket that can be used to secure the sensor to a wall or the side of a large drip tray. In some applications the mounting bracket may not be required and can be discarded. Two 4.5mm countersunk holes are provided for fixing or the bracket can be glue fixed. When fixing, the stainless-steel pins should be touching the floor providing the flooring is nonconductive i.e., concrete, wood or plastic. For conductive areas, the stainless-steel probes MUST NOT touch the surface, they must be raised to provide a 0.5mm gap between floor and sensor. Height adjustment is provided by sliding the sensor slightly out of its holder. The sensor can also be removed by sliding it out of its holder for testing, maintenance or when cleaning the floor.

For steel drip trays the sensor has been designed to be positioned on its back with the sensors either facing downward or upside down if a large amount of water is required before detection.

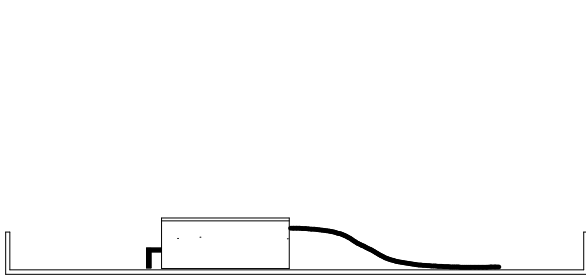
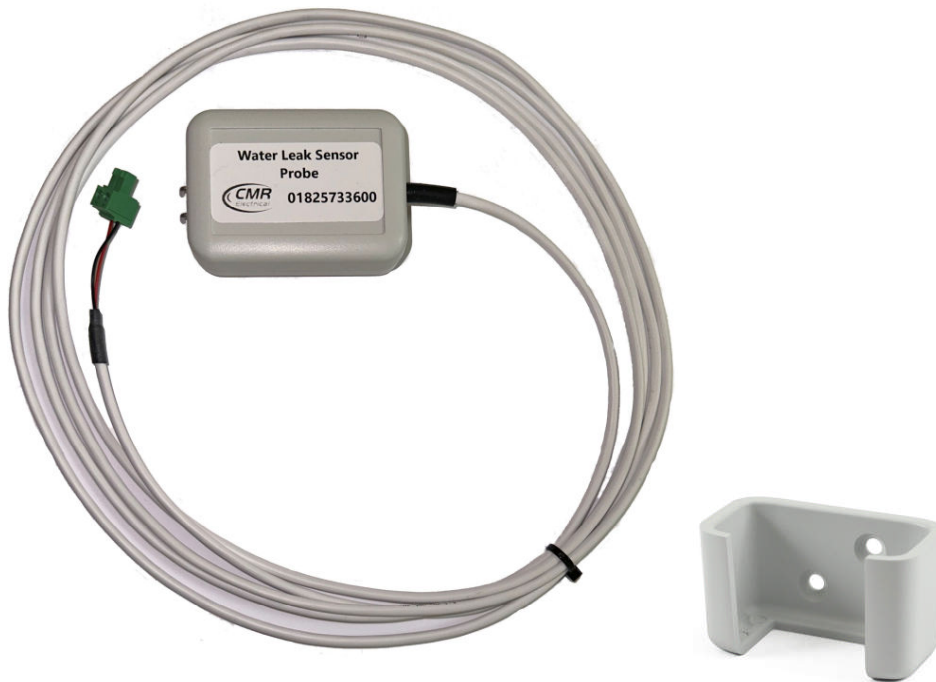

Drip tray without the mounting bracket



Deep drip tray side mounted using bracket (Sensor not to touch a conductive drip tray)

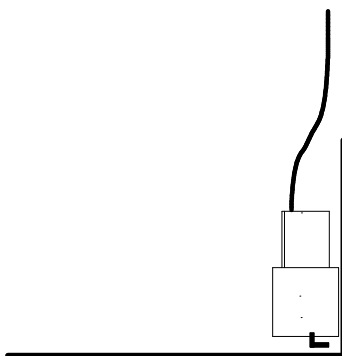

Mounting to a wall or structure (Sensor to touch floor unless floor is conductive)

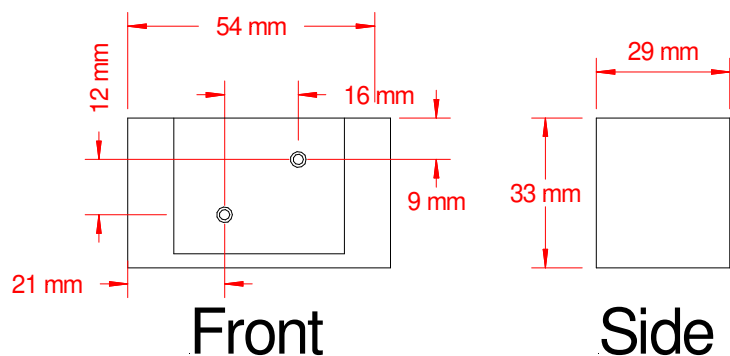

Mounting bracket fixing details

Once the sensor has been positioned, extend the white cable back to the alarm outstation using a 2-core cable, for example Belden 9502. Connect the two cables to the appropriate zone terminals using the removable green terminal block from the outstation. When making connections, ensure that the RED wire from the white cable is terminated to the zone terminal marked “Sig+” and the black cable to “Sig-“. Once both cables have been terminated, give a slight tug to each wire to ensure correct termination to the terminal block. Reversing the cabling will set the zone into “Alarm”, if this happens revert to the terminal connections.

19) Water Detection Sensitivity Adjustment

To increase the sensitivity of the cable, turn the potentiometer CLOCKWISE.
 To de-crease the sensitivity, turn ANTICLOCKWISE.

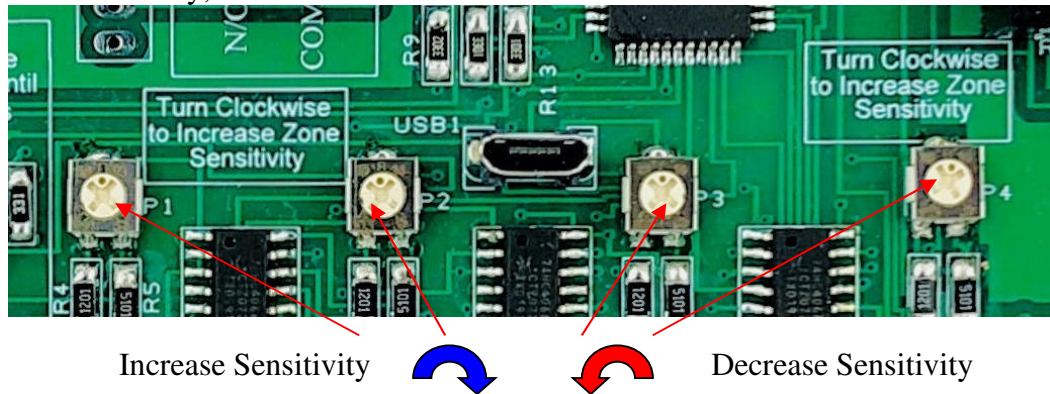

20) Water Shutdown Valve

Valves are controlled from the appropriate outstation and would have been factory set at the time of ordering i.e., each zone controls its own valve, all zones operate a common valve, zones 1 & 2 operate the same valve etc. Within the outstation, an override push button and light are provided to allow the water to be turned back on even though water is still being detected by the detection sensor as outlined in *Item 20* below.

Connection of Water Shutdown Ball Valve

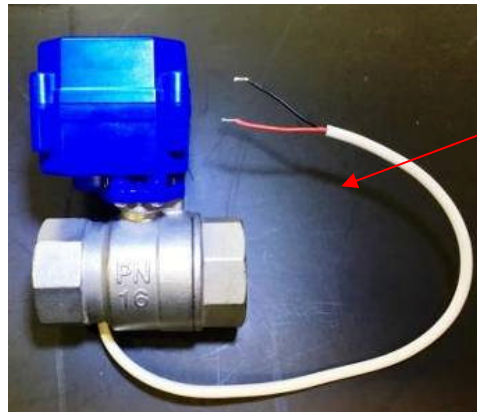

The 230VAC supply to the valve is generated from within the alarm unit.

15 to 25mm valves are supplied with a red and black cable whilst larger valves are red and green. For good practice connect live to the red wire and neutral to the black or green wire.

The Valve is supplied with a short length of cable that will need extending back to the Z1 or Z2 Valve terminals within the alarm unit.

Specification

Type Motor open, automatic close
 Voltage 230VAC
 Buren 5 watt moving, <1 watt maintaining
 Operation Powered Open, capacitor reserve used to close
 Controlled fluid temperature -15 to 100°C

Maximum Pressure

1/2"	3/4"	1"	1 1/2"	2"
0-10 bar	0-10 bar	0-10 bar	0-10 bar	0-10 bar

WARNING, In order to shut properly, this type of valve need powering for at least 3 minutes.

Connection of Water Shutdown Solenoid Valve

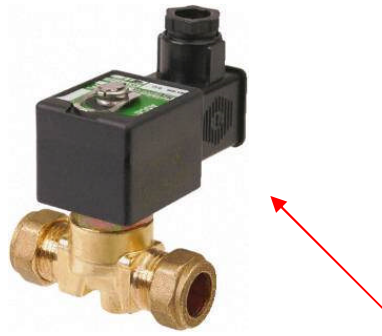

The 230VAC supply to the valves is generated from within the alarm unit.

Having removed and opened the 3 pin socket, connect:
Live to terminal “1”,
Neutral to terminal “2”
Earth to the earth terminal

PLEASE NOTE;

We don't recommend this type of valve and therefore it will NOT be supplied by CMR electrical. However, if this type of valve MUST be fitted, ensure that the arrow on its body is facing the direction of flow, if not, the valve will not stop the flow of water.

21) Water Shutdown Valve Override Procedure

Operating a shutdown override can only be carried out at the appropriate outstation and will only work if there is a current water leak detected alarm light illuminated on the outstation top PCB. To put the system into shutdown override and re-open the valve, press and keep pressed the “Override” push button. On pressing the button, the unit will start beeping, keep your finger on the button, wait for the beeping to stop. Once this happens the “override” light will illuminate and the valve “Closed” light will extinguish (*see above*) and the valve will open. You can now stop pressing the button. The system will automatically cancel the override once the zone stops detecting water.

22) Fitting the Battery Backup

The batteries should only be connected after the system has been commissioned. Connect the BLACK cable to the “—“ battery terminal on battery 1, connect the “+” terminal on battery 1 to the negative terminal on battery 2 and connect the white/red cable to the “+” terminal on battery 2. If the battery is misconnected, the battery fuse located on the PCB will blow.

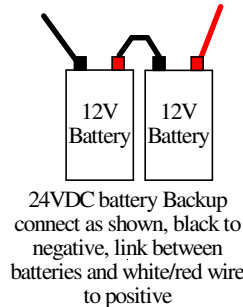

23) Commissioning

- Once the unit has been connected as described above, turn on the mains power to the unit. The screen should display “Setting up please wait”, *If not, refer to the “Fault Diagnostics” below.*
- If the unit powers up with the audible warning going, press the mute button and wait to see if the alarm clears. If the alarm remains after approximately 10 seconds, *refer to the “Fault Diagnostics” below.*
- With the unit powered with screen 1 (*Item 2*) above in the display, unplug the end of line terminator (*Item 15 above*), positioned at the end of the detection cable for zone 1, outstation 1. The controller should display screen 4 (*item 2 above*) and the audible warning device should sound, *if not refer to the “Fault Diagnostics” below.* Pressing the “Mute” button, the audible warning device should stop and screen 5 (*item 2 above*) should be on display. Replace the End of line terminator to return the system to normal and repeat for the other zone on outstation 1 and all other zones on all the other outstations.
- Using a cup of CLEAN water, immerse a small area (50mm long) of cable on zone 1, outstation 1, into the water. The controller should display screen 2 (*item 2 above*) and the audible warning device should sound, *if not refer to the “Fault Diagnostics” below.* Press the “Mute” button, the audible

warning device should stop and the display change to screen 5 (*Item 2 above*). Remove the water and wipe the cable with some tissue paper. Repeat for all other zones on outstation 1 and all zones on all the other outstations.

24) Maintenance

The system should be fully tested at least once a year for correct operation and if fitted, a check made to ensure that the shutoff valve operates correctly. All cables should be inspected at the same time for signs of damage, dirt contamination or mis-placement.

25) Fault Diagnostics

“Active” LEDS are provided on all outstations and the main alarm unit. The lights are provided to help when fault finding. When all interconnecting cabling is correct, the alarm unit “Active” LED should be ON and all the outstation “Active” LEDS should be flashing. If the alarm unit LED is OFF, it indicates that the controller can communicate to any of the outstations. If the alarm unit LED is flashing, it indicates that the controller is having difficulty or can’t communicate to some of the outstations. If an outstation “Active” LED is not flashing, it indicates that the controller can’t communicate with it.

Fault	Possible Reason
Display is OFF and the unit appears dead	<ol style="list-style-type: none"> 1) Alarm unit in power save mode. <i>Press the “Light” push button</i> 2) No power to the control unit. <i>Test with a meter</i> 3) The power fuse has blown. <i>Test the fuse with a meter</i>
Display is shows” SYSTEM FAULT”	<ol style="list-style-type: none"> 1) Power off and on again. <i>If this fails to resolve the problem contact the manufacturer</i>
All zones are displaying “FAULT”	<ol style="list-style-type: none"> 1) If the “Active” LED next to the display is permanently ON. <i>All sensors on all outstation could be disconnected. Press one of the outstation “Test” buttons to see if the statement changes to “Alarm” (screen 2 above). If the answer is yes, the sensors are disconnected.</i> 2) If the “Active” LED next to the display is OFF. <i>Disconnected cable between the alarm unit and all outstations.</i> 3) If the “Active” LED next to the display is flashing. <i>Disconnected or wrongly cable between the alarm unit and all outstations.</i>
Display is showing some zones as “NORMAL” and some as “FAULT”	<ol style="list-style-type: none"> 1) Check that all outstation “Active” LEDS are flashing. <i>If one or more are not flashing, disconnected or wrongly connected data cable to that outstation.</i> 2) <i>If all are flashing, disconnected sensor or sensors.</i>
All zone sensors are fitted correctly but the display is showing some zones in “FAULT”	<ol style="list-style-type: none"> 1) If the “Active” LED next to the display is permanently ON. 2) If the “Active” LED next to the display is OFF. <i>Disconnected cable between the alarm unit and all outstations.</i> 3) If the “Active” LED next to the display is flashing. <i>Disconnected or wrongly cable between the alarm unit and all outstations.</i> 4) Check that all outstation “Active” LEDS are flashing. <i>If one or more are not flashing, disconnected or wrongly connected data cable to that outstation,</i> 5) Take a note of what zones are normal and in alarm and turn off the controller then back on again. <i>If different zones go into alarm and normal, this indicates a Disconnected or wrongly connected data cable</i>
The display appears dead	<ol style="list-style-type: none"> 1) Check that the “Active” LEDs on the controller is ON, that all outstation “Active” LEDS are flashing and press one of the outstation “Test” buttons to simulate an alarm. <i>If all looks correct but the display fails to react return to manufacturer</i>
The system will not record a water detected alarm, the Display and audible warning device do not react to water on the cable	<ol style="list-style-type: none"> 1) Sensitivity could be too low or a possible system fault. <i>Remove the lid from the small plastic box connected to the detection cable and turn the potentiometer until the system goes into alarm.</i> 2) System fault. <i>Return to manufacturer</i>
Horn not working	<ol style="list-style-type: none"> 1) System fault. <i>Return to manufacturer</i>
The battery will not power the system	<ol style="list-style-type: none"> 1) Battery discharged, disconnect a lead and test with meter. 2) Battery fuse blow 3) Charger fault, disconnect a battery lead & check for 26.5V

26) Installation Drawings

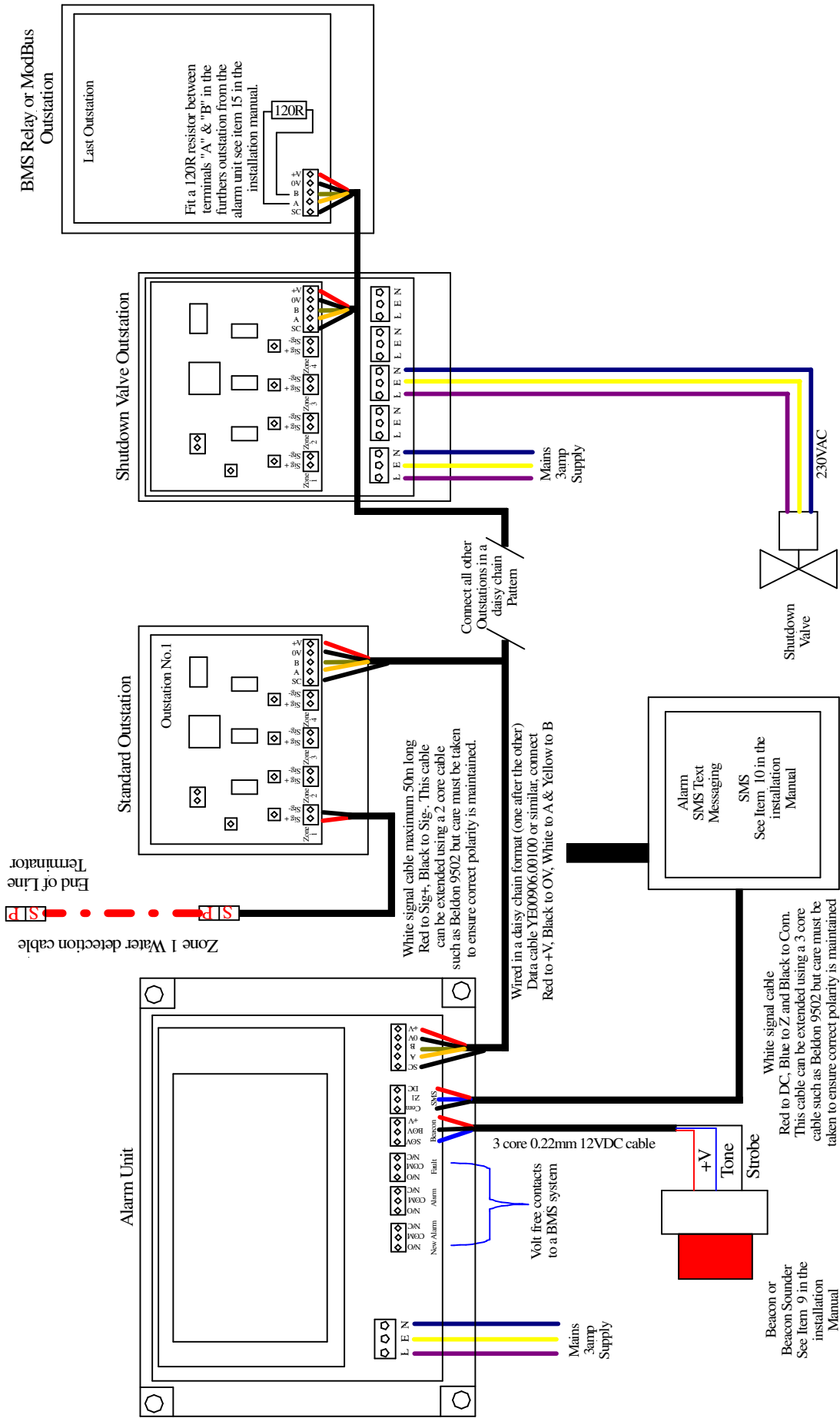

27) Optional Modbus TCP interface

If the optional Modbus TCP interface box has been provided, the housing can be positioned in a convenient position to allow both the LD32 RS485 and the BMS RJ45 ethernet cable to be terminated. Once positioned, connect the LD32, RS485 cable to the indicated terminal block in the same way as the outstations, then plug in the RJ45 connector to any RJ45 socket. Modbus interface is via one or more Brainbox ED516 Modbus modules, each giving a zone alarm Status high (1) for alarm and zero (0) for zone clear.

Modbus is provided by using 16 channel digital input to Modbus modules type ED516. If the number of zones exceeds 16, a number of Modbus modules will be provided depending on the total number of zones i.e. zones 1-16 = one module, up to 32 zones will be two modules etc. As each ED516 module only has one RJ45 port, if multiple modules are required, a 4 way ethernet switch will be provided.

The ED516 by default will be set to use DHCP and will obtain an IP from a networks DHCP server if available. For the first 30 seconds after boot, all ED516 devices will attempt to locate and negotiate an IP address from a DHCP server. If after 30 seconds no IP is given to the device, it will default to a temporary IP of: **192.168.127.254**. All ED516 devices will do this and could cause problems on a network. Depending on the network arrangement, you may wish to utilise DHCP for their ED516's, although you'll most probably prefer assigning static IP's to each device. Not only will this allow the ED516's to come online straight away (at their static IP), it also ensures they're always available at the same IP addresses. This isn't something that can be guaranteed through the DHCP process, as 'DHCP Leases' can see a devices IP change for various reasons.

There are two options to assign the ES516 with a static IP address as outlined below.

- Option 1 would be to use our Boost.IO software. This would require the ED516 device to be connected to a PC (either directly or over the network) and on the same subnet.
- Option 2 would be to use the web interface. As before, this would require the device to be connected to your PC (either directly or over the network) and on the same subnet.

Through either option, you'll then be able to set the device to static and assign valid IP addresses.

For more information and support for the Brainbox ED516 use the following link.

<https://www.brainboxes.com/files/catalog/product/ED/ED-527/documents/Brainboxes%20Modbus%20TCP%20Manual.pdf>

The following link is the Brainbox Support link

<https://www.brainboxes.com/support>

Or contact Brainbox UK at, Brainboxes Limited, 18 Hurricane Drive, Liverpool International Business Park, Speke, Liverpool, Merseyside, L24 8RL Tel: +44 (0)151 220 2500 Fax: +44 (0)151 252 0446
www.brainboxes.com | sales@brainboxes.com | support@brainboxes.com

Modbus interface housing

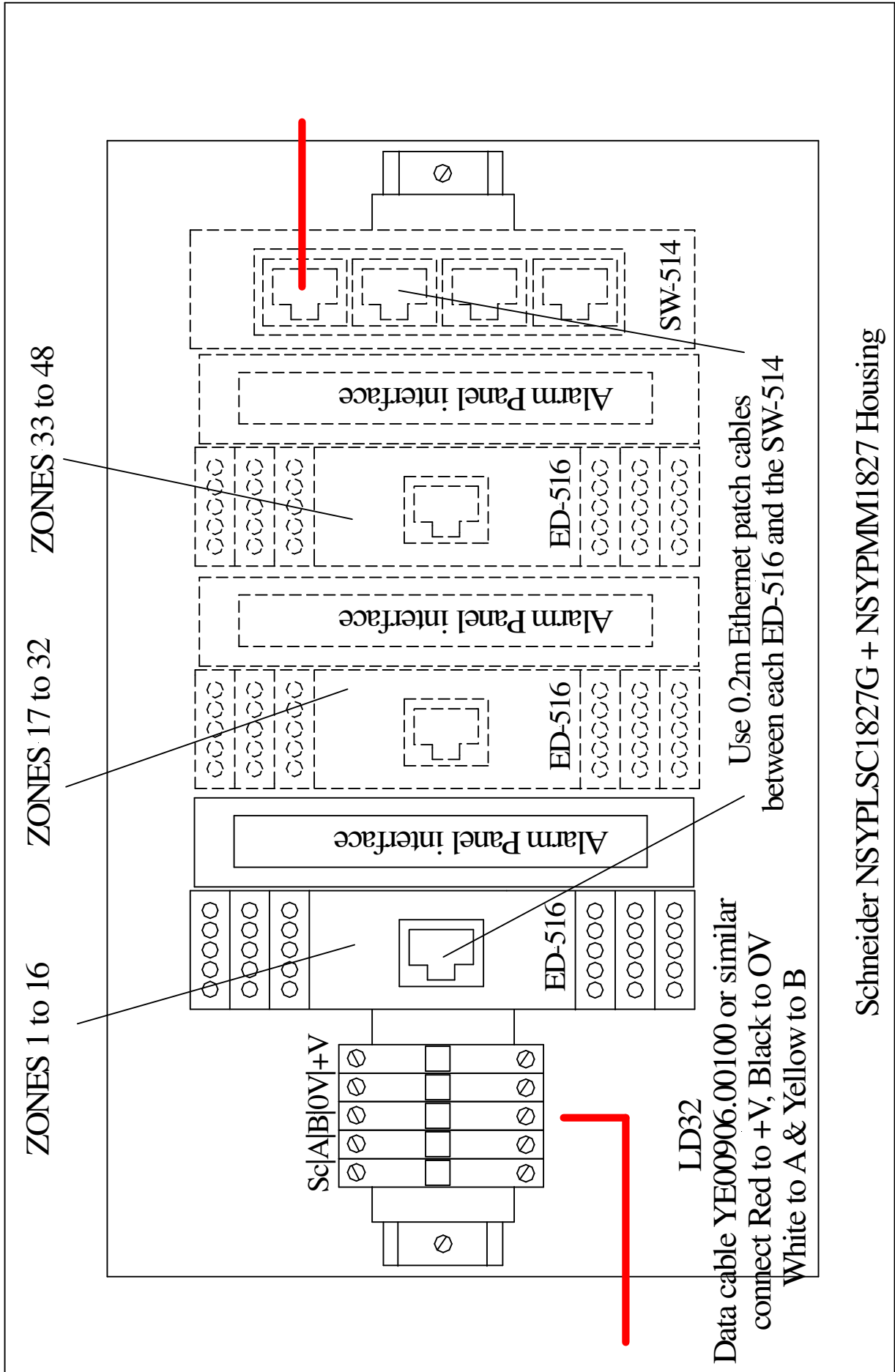

Schneider NSYPLSC1827G + NSYPMM1827 Housing